

Propane Portable Water Heater

Installation and instructions Manual

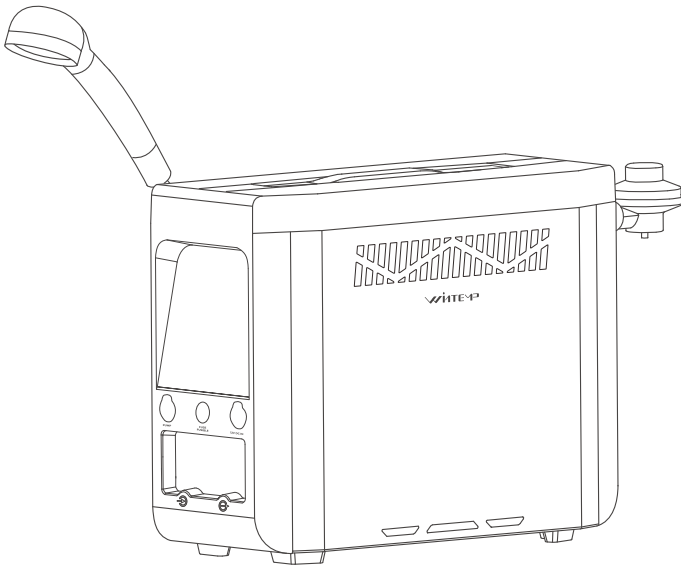

Model No. **GPT3U**

Before first use, please fully charge the battery before use. Please read this manual carefully before use and keep it properly for further reference.

Please read and follow the installation and operation instructions carefully to ensure the long life and reliable performance of this appliance.

CONTENTS

- WARNING 2
- SPECIFICATIONS 5
- PRODUCT OVERVIEW 6
- PANEL INTRODUCTION 7
- OPERATING PRECAUTIONS 7
- PRODUCT ACCESSORIES 8
- INSTALLATION AND USAGE TUTORIALS 9
- TROUBLESHOOTING GUIDE 12
- ERROR CODE DEFINITION 13
- CIRCUIT DIAGRAM 14
- WARRANTY AND MAINTENANCE 15
- INSTRUCTIONS FOR USE 16

WARNING

DANGER

■ **CARBON MONOXIDE HAZARD**

- When the water heater starts to heat water, propane inside may produce carbon monoxide during combustion.
- Using it in an enclosed space can cause death.
- Never use this appliance in an enclosed space such as a camper, tent car or home.



■ **EXPLOSION-FIRE HAZARD**

- Never store propane near high heat, open flames, pilot lights, direct sunlight, or other ignition sources or where temperatures exceed 120°F (49°C).
- During operation, this product can be a source of ignition.
- Never use this appliance in spaces that contain or may contain volatile or airborne combustibles, or products such as gasoline, solvents, paint thinners, dust particles or unknown chemicals

- Water temperatures over 125°F (52°C) can cause severe burns instantly or death from scalds. Children the disabled and the elderly are at the highest risk of being scalded. See the instruction manual before setting the temperature at the water heater. Feel water before bathing or showering.

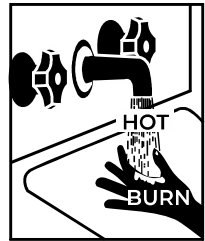

WARNING

■ **YOUR SAFETY IS IMPORTANT, SO PLEASE READ THESE INSTRUCTIONS BEFORE OPERATION.**

- This manual contains important information about the assembly, operation and maintenance of this appliance.
- Safety precautions are essential when any mechanical or propane fueled equipment is involved. These precautions are necessary when using, storing and servicing. Following these safety alerts will reduce the possibility of personal injury or property damage.
- Propane cylinders must be disconnected when this appliance is not being used or when storing this appliance. Cylinders must be stored outdoors in a well-ventilated space and out of the reach of children.

WARNING

- Only use this appliance in well-ventilated areas. It should only be operated in an above-ground, open-air situation where there is natural ventilation, no stagnant areas, and where gas leakage and/or products of combustion will be promptly diffused by wind and natural convection.
- Not for home or recreational vehicle use.
- The water heater is for point of use, for temporary water heating and not for connection to a permanent inlet water connection or for connection to a water distribution system to supply multiple outlets.
- Do not operate this appliance where flammable liquids or vapors may be present.
- This appliance shall only be used with the regulator supplied with the appliance, Do not attempt to adjust.
- This appliance shall only be used with the regulator supplied with the appliance, Do not attempt to adjust.
- Any alteration to the appliance or its controls can cause unforeseen serious hazards and will void the warranty. **DO NOT MODIFY THIS APPLIANCE.**
- Never install or remove propane tank while this appliance is operating, near flame, other ignition sources or while this appliance is hot to the touch.

WARNING

- This appliance is not intended for the supply of drinking water. Drinking water heated by this appliance can cause health risks.
- This appliance is intended for the supply of heated water for the purpose of washing and cleaning only.
- Check and confirm safe water temperature before using this appliance. Water from this appliance may be very hot.

WARNING

1. Never store propane near high heat, open flames, pilot lights, direct sunlight, other ignition sources or where temperatures exceed 120°F (49°C).
2. Propane is heavier than air and can accumulate in low places. If you smell gas, leave the area immediately.
3. Never install or remove propane tank while this appliance is operating, near flame, pilot lights, other ignition sources or while this appliance is hot to touch.
4. During operation, this appliance can be a source of ignition. Never ignite or use this appliance in spaces that contain or may contain volatile or air-borne combustibles, or products such as gasoline, solvents, paint thinner, dust particles or unknown chemicals. Minimum clearances from combustible materials: 12 inches (30.5 cm) from sides & 48 inches (122 cm) from the top.
5. Provide adequate clearances around air openings into the product. Do not obstruct the flow of combustion and ventilation air.

WARNING

• If you smell gas:

1. Shut off gas to the appliance.
2. Extinguish any open flame.
3. If odor continues, keep away from the appliance and immediately call the fire department. Failure to follow these instructions could result in fire or explosion which could cause property damage, personal injury or death.

WARNING

1. Failure to comply with the precautions and instructions provided with this product can result in death, serious bodily injury and property loss or damage from hazards of fire, explosion, burn, asphyxiation, and/or carbon monoxide poisoning.
2. Only persons who understand and follow the instructions can use or service this product.
3. If you need assistance or information such as an instruction manual or labels, please contact WINTEMP.

WARNING

1. Never leave this appliance unattended when hot or in use.
2. Do not touch metal parts and venting holes of the heater, which may get very hot when in use. Keep out of reach of children.
3. THIS APPLIANCE IS NOT INTENDED FOR THE SUPPLY OF DRINKING WATER.

WARNING

1. This product is fueled by propane gas. Propane gas is invisible, odorless, and flammable. An odorant is normally added to help detect leaks and can be described as a "rotten egg" smell. The odorant can fade over time so leaking gas is not always detectable by smell alone.
2. Propane gas is heavier than air and leaking propane will sink to the lowest level possible. It can ignite by ignition sources including matches, lighters, sparks or open flames of any kind many feet away from the original leak. Use only propane gas set up for vapor withdrawal.
3. Gas cylinders must be stored outdoors in a well ventilated area and out of the reach of children. Any indoor storage should comply with AS/NZS 1596.
4. Disconnect propane before storing this appliance.

WARNING

• When using electrical products, basic precautions should always be practiced including the following:

1. READ AND FOLLOW ALL SAFETY INSTRUCTIONS.
2. Read and follow all instructions that are on the product or provided with the product.
3. For a cord-connected or direct plug-in power unit, do not use an extension cord.
4. Do not install or use within 10 feet (3 m) of a pool.
5. Do not use in a bathroom.

WARNING: Risk of Electric Shock, When used outdoors, install only to a covered Class A GFCI protected receptacle that is weatherproof with the power unit connected to the receptacle. If one is not provided, contact a qualified electrician for proper installation. Ensure that the power unit and cord do not interfere with completely closing the receptacle cover.

SPECIFICATIONS

Model	GPT3U
Dimensions(LxDxH)	14.9x6.7x11.8in
Electrical Input:	DC 12V
Rating: BTU	8000-20000 BTU
Water Yield: GPM	0.53-0.84GPM
Fuel Supply Pressure (to regulator):	Max Bottle Pressure
Weight(LBS):	13.7LBS
High Temperature Control:	122°F
Fuel Source:	Propane
Materials:	PA66+GF+UV
Battery:	21700battery pack(4000mAh)
Run Time (Full Charge):	120minutes
Charging Time:	≈2h(attain 80%)

PRODUCT OVERVIEW

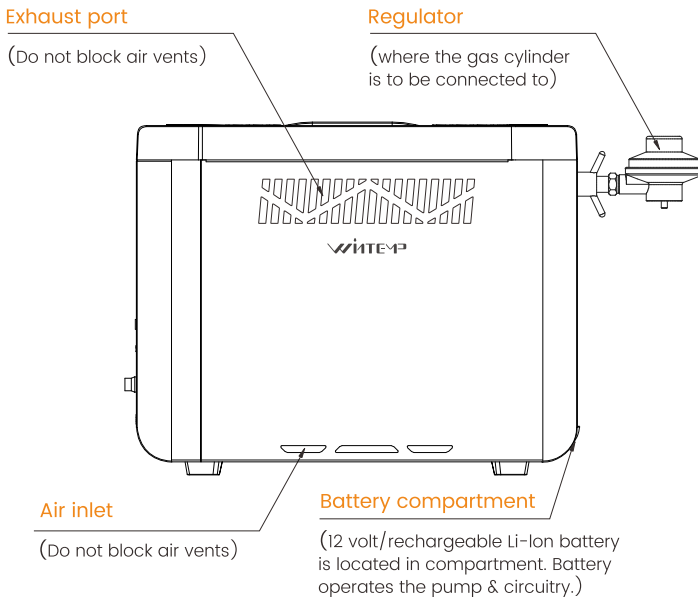
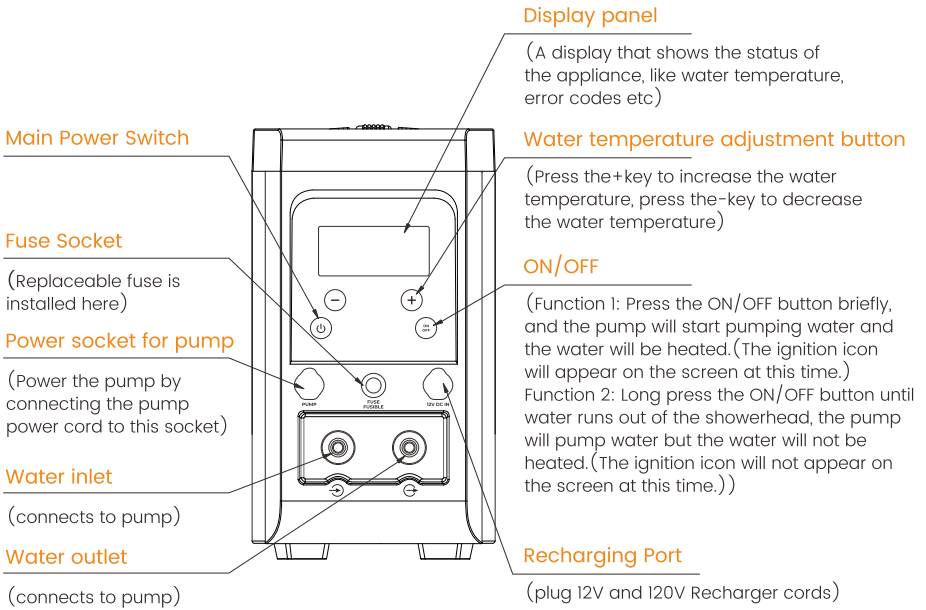

PANEL INTRODUCTION

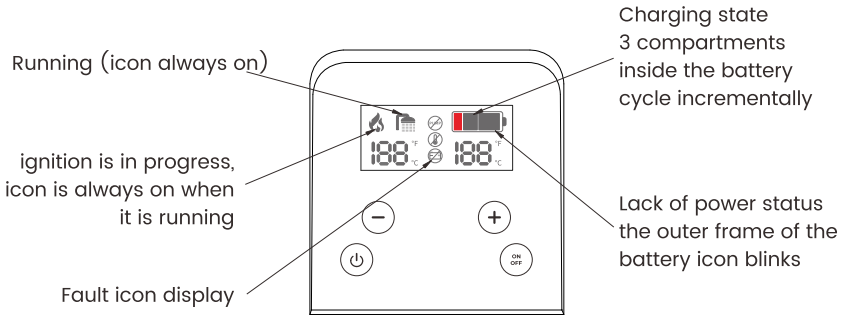

OPERATING PRECAUTIONS

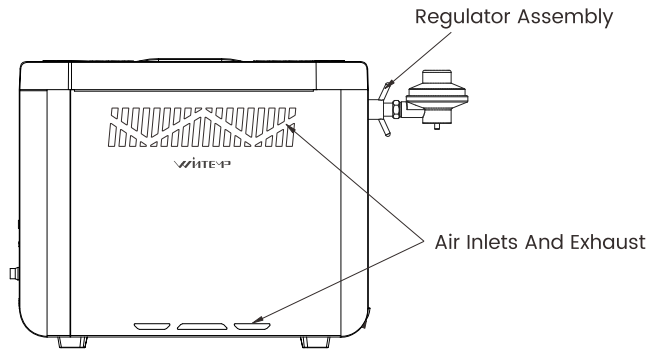

1. During operation, please ensure that all air inlets and exhaust (front, sides and bottom) are kept free from obstructions and closure.
2. Attach the supplied regulator by rotating the t-wing nut in a "clockwise" direction carefully not to over tighten.
Tips: Press the air valve tightly with one hand, and tighten the T-nut with one hand.

CHECKING FOR GAS LEAKS

1. During set up, use soapy water to check all the connections and fittings that should be sealed for leaks. Never use a flame to check for gas leaks. Bubbles indicate a leak. If bubbles appear, you will need to tighten the connection before testing again. Check that the connection is not cross threaded and that it is tight. Perform another leak check.
2. If there is still a leak, please remove the cylinder and contact a professional for repair.
3. Do not turn this appliance on until all connections have been leak tested and do not leak.
4. Inspect this appliance regularly for signs of wear, leaks or incorrect operation. If symptoms such as flaring of the burners, issues with lighting, damages to connections or leaks from seals or gas controls are identified, do not attempt to repair these issues on your own, please contact a professional for repair.
5. Do not use this appliance if it has damaged or worn seals. Do not use this appliance if it is leaking, damaged or does not operate properly.

PRODUCT ACCESSORIES

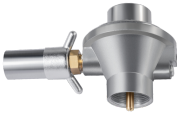

Gas Regulator



Auto Recharger Cord
(12 Volt) 5m



Magnetic shower
Holder



Household Recharger Cord
1.8m



Pump Assembly
1.5m



Shower Head Attachment
2.5m

INSTALLATION AND USAGE TUTORIALS

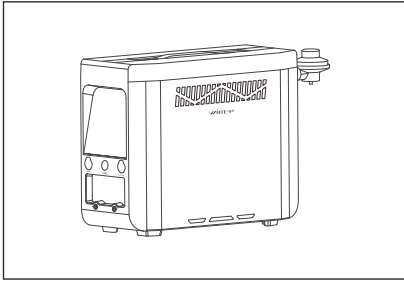

Fig.1

Place the appliance on a solid, non-combustible surface and straighten out all hoses to remove any kinks or twists.

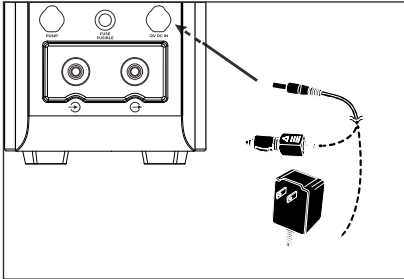

Fig.2

Charge the battery before using the water heater for the first time.

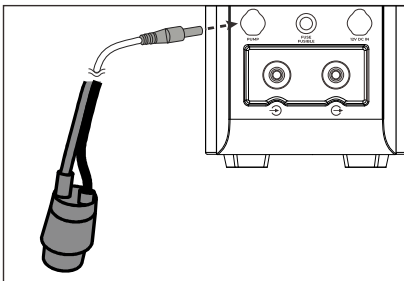

Fig.3

Plug the power cord of the pump into the power input labeled PUMP.

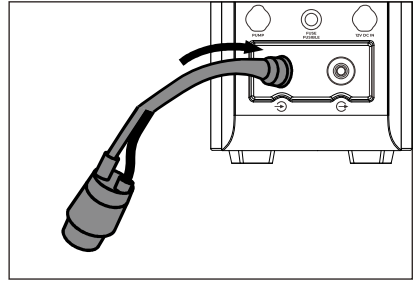

Fig.4

Connect the pump assembly into the water inlet.

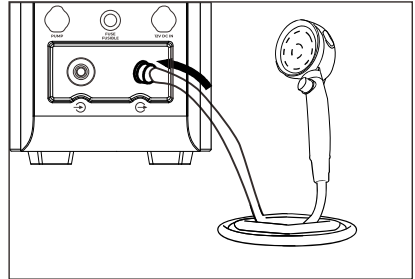

Fig.5

Attach the shower hose using the quick connect fitting, and ensure that the flow switch on the shower head is in the ON position.

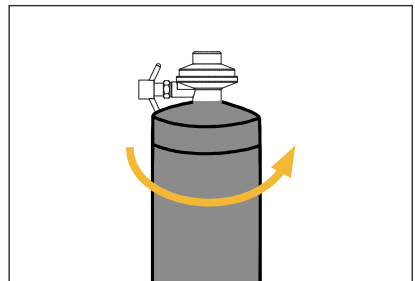

Fig.6

While holding the propane cylinder upright, thread it into the regulator and tighten correctly.
NOTE: This appliance shall only be used with 1 lb. Propane LPG disposable gas cylinders.

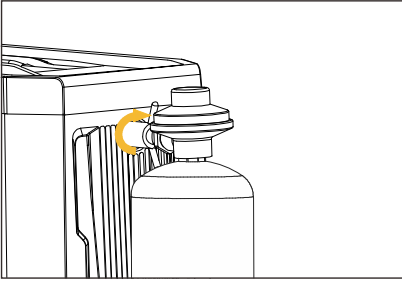

Fig.7

Install the regulator assembly to the appliance. When installing the regulator assembly, push it in slightly and hold so that it can press against the gas inlet connector, then turn the T-nut to tighten it at the same time.

Tips: Press the air valve tightly with one hand, and tighten the T-nut with one hand

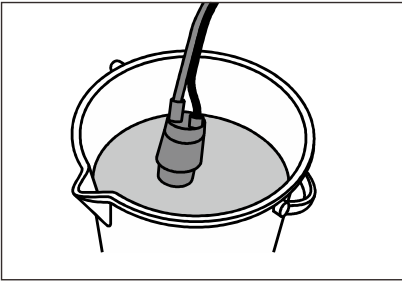

Fig.8

Submerge the pump in a suitable reservoir of water, DO NOT use water directly from rivers, lakes or the ocean. DO NOT use salt water with this appliance.

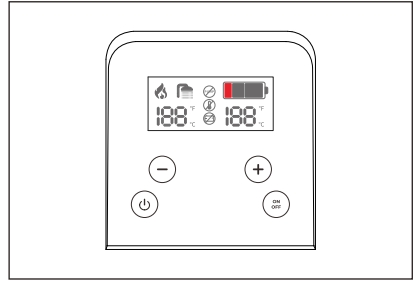

Fig.9

The main power switch "⏻". Start-up feedwater pump "ON/OFF".

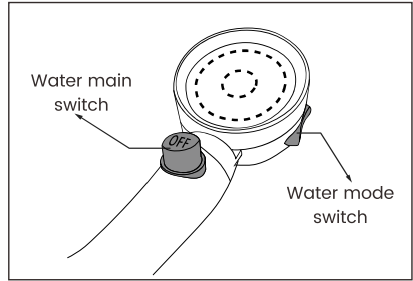

Fig.10

Sliding the flow switch to the OFF position, the burner will extinguish and the pump will continue to operate 120s.

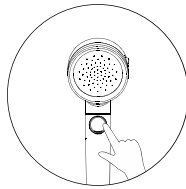

Fig.11

Installation of the shower packet.

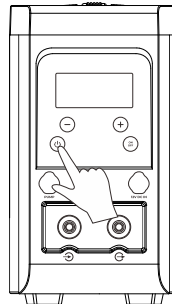

Fig.12

Once you have finished showering or using the hot water, please press the switch button on the showerhead to stop the flow of water, then press the "ON/OFF" button to stop the water pump from working. Finally, press the "⏻" button on the panel to turn off the screen and power down the heater.

Removing The Propane Tank

1. Check that the internal burner is fully extinguished, the heater is entirely powered down, and all surfaces are cool to the touch.
2. Unscrew the gas regulator from the gas inlet at the rear of the heater by turning it in a counter-clockwise direction.
3. Unscrew the regulator connection from the propane tank by turning it in a counterclockwise direction.

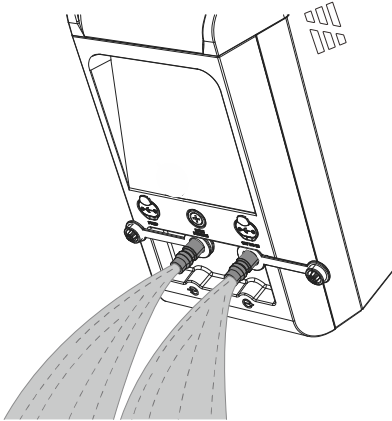

Fig.13

After use, pour out the water inside the appliance. Do not store this appliance until the water has been poured out.

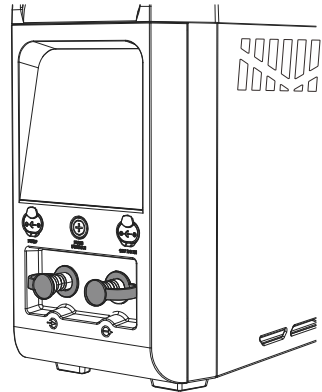

Fig.14

Use two silicone plugs to block the water inlet and outlet holes to prevent water from flowing out during transportation.

About the inlet and outlet water temperature:

This appliance is designed to be used with an inlet water temperature of 68°F or below. This appliance is designed to raise the outlet water temperature by a maximum (average) of 23°F to 42.3°F above the inlet water temperature and the outlet water temperature can be adjusted by the flame size adjustment knob.

For safety considerations, the appliance is designed to shut off the burner when the outlet water temperature exceeds 122°F + / - 3°F (average).

TROUBLESHOOTING GUIDE

Symptom	Possible Cause	Solution
Hot water warning	Environment temperature is high	Turn control knob to a cooler setting
	Temperature sensor defective	Contact WINTEMP for help
Tilt warning	Heater is tilted more than 30 degrees	Gas & pump will be shut off immediately
	Max. Bottle Pressure	Contact WINTEMP for help
Flames out warning	Flames blown out by strong wind/pilot light is out	Do not use in strong wind condition. Turn off the heater completely and restart the ignition sequence
	Flame detection module defective	Contact WINTEMP for help
Low battery warning	Battery voltage lower than 9.2V	Recharge the battery
	Defective battery	Contact WINTEMP for help
No water source detected	Pump is not in correct position	Put the pump in the water
	Water tank/carrier out no water	Fill water tank/carrier with water
	Pump inlet screen clogged	Clean the pump inlet screen, seen instructions given in maintenance section
	Hose twisted/kinked	Straighten hose
Burner will not light	Battery lead disconnected	Remove battery cover & reinstall lead
	Pump power cord disconnected	Plug cord into power socket on heater
	Low battery	Recharge the battery
	Flow rate sensor defective	Contact WINTEMP for help
	Propane cylinder empty	Replace cylinder
	Propane cylinder frosted	Replace cylinder and reuse after thawing
	Fuse defective	Refer to maintenance section and replace the fuse
	Electronic circuit defective	Contact WINTEMP for help
Water leakage	Sleeved-connectors were not locked into place	Read instructions for connecting sleeved connectors and reconnect the connectors
	Defective seal or break	Replace sealing components (O-rings) or send to WINTEMP when necessary
Battery won't hold a Charge	Defective Battery	reinstall lead
No display	Battery lead disconnected	Remove battery cover & reinstall lead
	Fuse defective	Refer to maintenance section and replace the fuse
	Electronic circuit defective	Contact WINTEMP for help
	Low battery	Recharge the battery

ERROR CODE DEFINITION

LED DIAGNOSTIC		
Code	Code Definition	Solution
E0	Outlet Water Temperature Sensor Failure	Restart the appliance one to two times. If it continues to report malfunction, contact WINTEMP to the problem.
E1	Unsuccessful Ignition/ Flame OUT	Situation 1: Accidental flameout, restart the appliance. Situation 2: Gas pressure too high or too low, cylinder needs to be replaced (must use original regulator and regulator assembly provided by WINTEMP). Situation 3: Incorrect gas type, check gas type. If it continues to report malfunction, contact WINTEMP to the problem.
E2	Flame Sensor Error	Restart the appliance one to two times. If it continues to report malfunction, contact WINTEMP to the problem.
E3	The appliance keep burning without water	Restart the appliance one to two times. If it continues to report malfunction, contact WINTEMP to the problem.
E4	Inlet Water Temperature Sensor Failure	Restart the appliance one to two times. If it continues to report malfunction, contact WINTEMP to the problem.
E6	Outlet High Water Temperature Protection(122°F, 50°C)	Situation 1: Check if the inlet water temperature is too high, if yes, use the flame size adjustment knob to lower the outlet water temperature setting. Situation 2: Water inlet and outlet flow is too low, clean the shower and clean the pump; Turn up the shower water flow switch. Situation 3: Restart the appliance one to two times. If it continues to report malfunction, contact WINTEMP to the problem.
E9	Tilt Protection	Situation 1: The appliance is tilted at an angle greater than 30° Straighten the appliance and restart it one to two times. If it continues to report malfunction, contact WINTEMP to the problem.
EC	Display screen communication malfunction	Restart the appliance one to two times. If it continues to report malfunction, contact WINTEMP to the problem.
EN	Timed shutdown	Restart the appliance one to two times. If it continues to report malfunction, contact WINTEMP to the problem.

CIRCUIT DIAGRAM

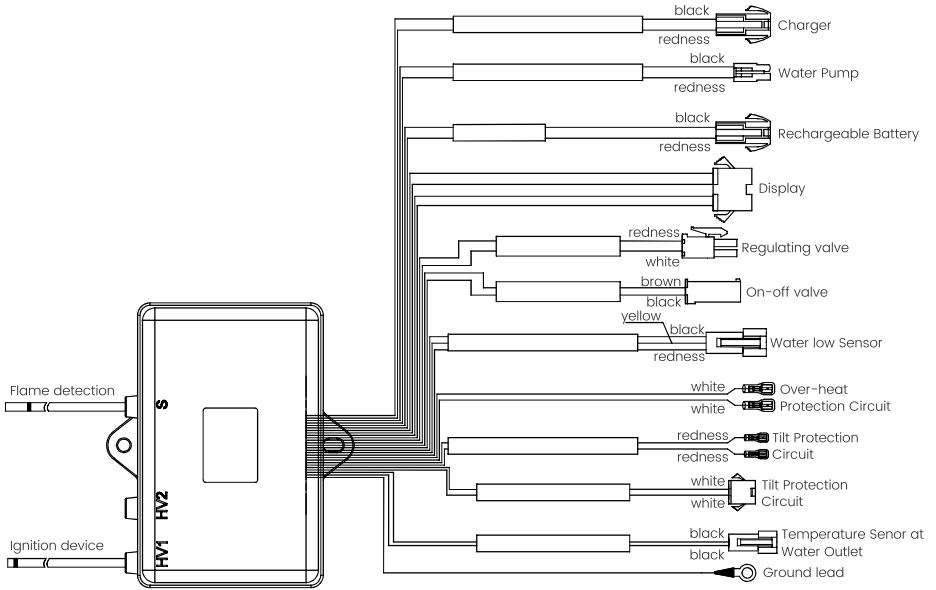

WARRANTY AND MAINTENANCE

Warranty

Except the following situations:

- Contrived damage.
- Damage caused by force majeure such as earthquake, conflagration, etc.
- Damage from inappropriate use or violating this instruction.
- Damage or malfunction caused by disassembling.

 24-month limited warranty

 Lifetime technical support

Packing list:

Item	Unit	Quantity
Propane Portable Water Heater	Unit	1
Magnetic Shower Holder	Set	1
Operation and Installation instructions	Copy	1
Submersible Pump Assembly(12V)	Piece	1
Shower Assembly	Set	1
Automatic Pressure-Reducing Valve	Piece	1
Igniter Adapter Head	Piece	1
Power Adapter(12V)	Piece	1

INSTRUCTIONS FOR USE

Outdoor use only

- THIS APPLIANCE IS INTENDED FOR THE SUPPLY OF HEATED WATER FOR THE PURPOSE OF WASHING AND CLEANING ONLY.
- THIS APPLIANCE IS NOT INTENDED FOR THE SUPPLY OF DRINKING WATER.
- NOT FOR HOME OR RECREATIONAL VEHICLE USE.
- THE WATER HEATER IS FOR POINT OF USE, FOR TEMPORARY WATER HEATING AND NOT FOR CONNECTION TO A PERMANENT INLET WATER CONNECTION OR FOR CONNECTION TO A WATER DISTRIBUTION SYSTEM TO SUPPLY MULTIPLE OUTLETS.

Our official website address
www.wintempshop.com

Install QR code

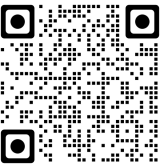

To obtain the benefit of this warranty, please email
support@wintempshop.com.
We will address your issue as soon as possible!

